

CABO B

RESORT EXTRUSIONS

PRODUCT CODE: CABOMTX-B



On frame On graphic

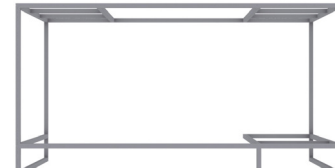
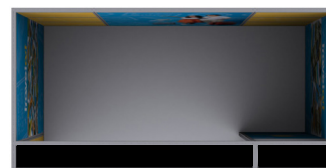
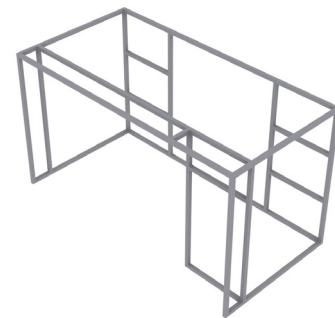
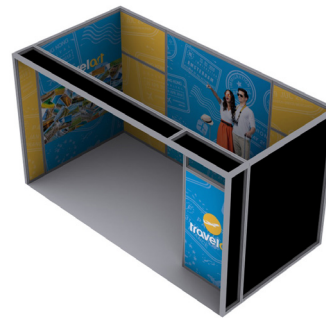
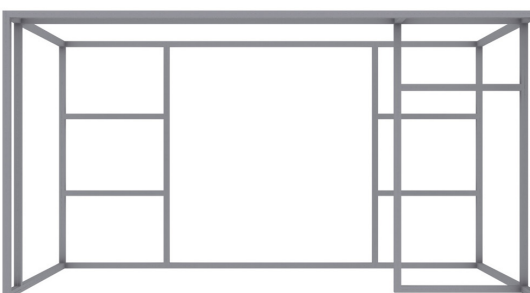
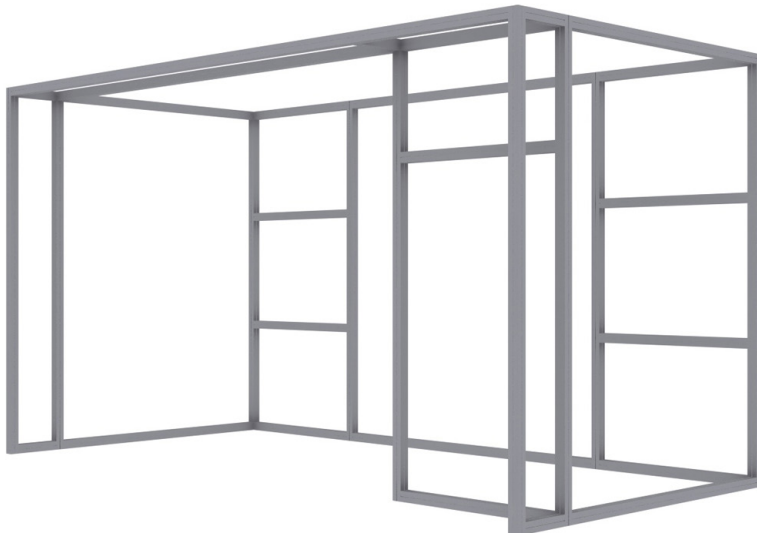

PRODUCT DESCRIPTION

The Cabo aluminum extrusion profile system is an elegant and versatile solution for all of your display needs. Featuring a sleek silver anodized finish, the Cabo is the perfect solution for tradeshow booths, retail environments, pop up shops, or any place aluminum framing is needed. The profiles are available in standard 40mm and 80mm profile widths and in different shapes allowing you to turn your display vision into reality. Promote your company, new products, etc with custom dye sublimated fabric graphics. 12mm x 3mm silicone beading (SEG) is sewn around the perimeter of each fabric panel for easy installation and removal of your graphics. Choose from one of our pre designed configurations or contact us for a quote on something totally custom.

DISPLAY DIMENSIONS	237"W x 133.25"H x 120"D
GRAPHIC SIZE	See Template Page

GRAPHIC MATERIAL

Dye-Sub Black & White Fabric

GRAPHIC FINISHING

12mm x 3mm silicone beading is sewn around the perimeter of the fabric graphic. Silicone beading is hidden from view once installed.

DISPLAY CONSTRUCTION

Extruded aluminum profile frame with aluminum and steel components

SHIPPING WEIGHTS & DIMENSIONS

Shipping Weight (LTL weight includes crate)	903 lbs (frame only) - LTL ONLY
	946 lbs (frame & graphic) - LTL ONLY
	40 lbs (graphic only) - UPS
Shipping Dimensions	102"L x 49.5"W x 44.5"H (Graphic Package & Hardware Only)

GRAPHIC TURN AROUND TIME

5 business days after proof approval for up to 2 booths

AVAILABILITY	PFC
--------------	-----

PARTS LIST HARDWARE ONLY

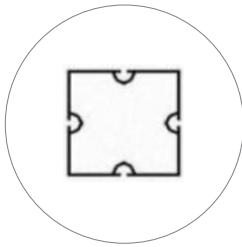

CABO-80 66.65" W
(qty 18)

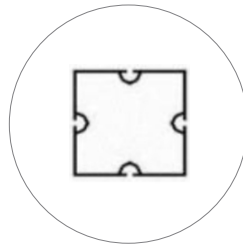

CABO-80 76.9" W
(qty 3)

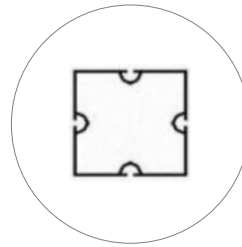

CABO-80 86.1" W
(qty 2)

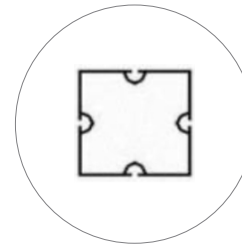

CABO-80 56.9" W
(qty 4)

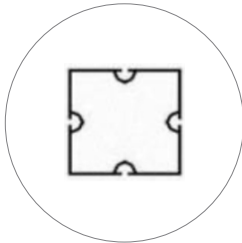

CABO-SEG-PLASTIC 94.3" W
(qty 4)

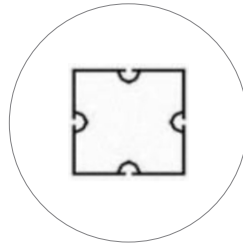

CABO-SEG-PLASTIC 55.3" W
(qty 11)

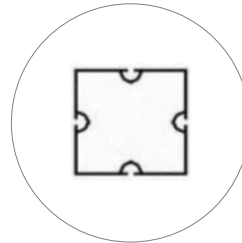

CABO-SEG-PLASTIC 16.3" W
(qty 5)

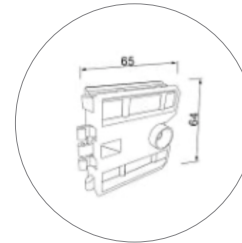

CABO-80-LOCK
(qty 50)

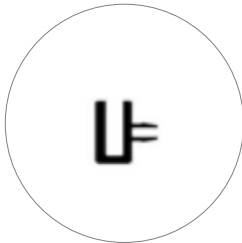

CABO-SEG-PLASTIC 16.3" W
(qty 8)

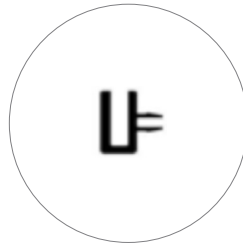

CABO-80-SEG 39.3" W
(qty 8)

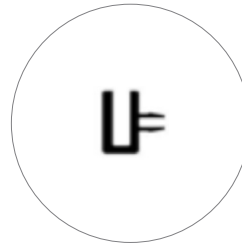

CABO-80-SEG 41.9" W
(qty 4)

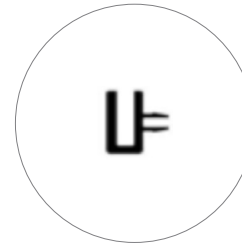

CABO-80-SEG 55.2" W
(qty 14)

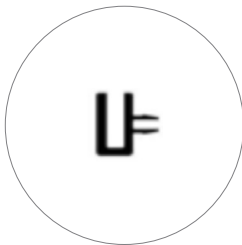

CABO-80-SEG 94.2" W
(qty 57)

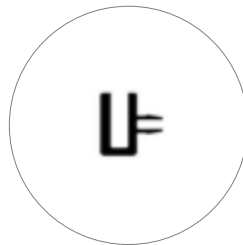

CABO-80-SEG 113.2" W
(qty 2)

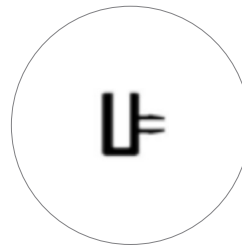

CABO-80-SEG 126.9" W
(qty 10)

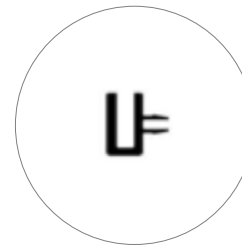

CABO-80-SEG 172.2" W
(qty 2)

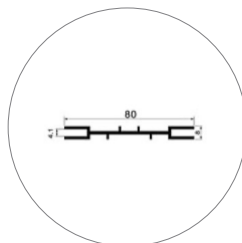

CABO-80-SEG 55.2" W
(qty 2)

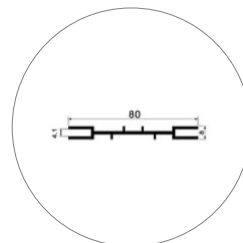

CABO-80-SEG 594.4" W
(qty 2)

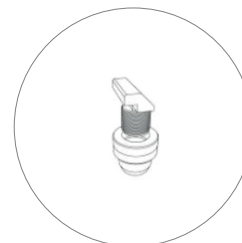

CABO-HHS
(qty 25) a

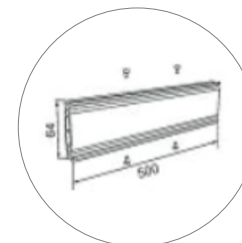

CABO-80-ADPT
(qty 14)



CABO-LTORX
(qty 1)



CABO-TSCREWDRIVER
(qty 2)



CABO-TTORX
(qty 1)



CABO-TTORX
(qty 1)

Frame Assembly

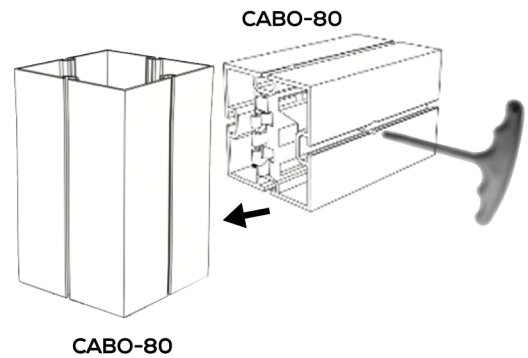
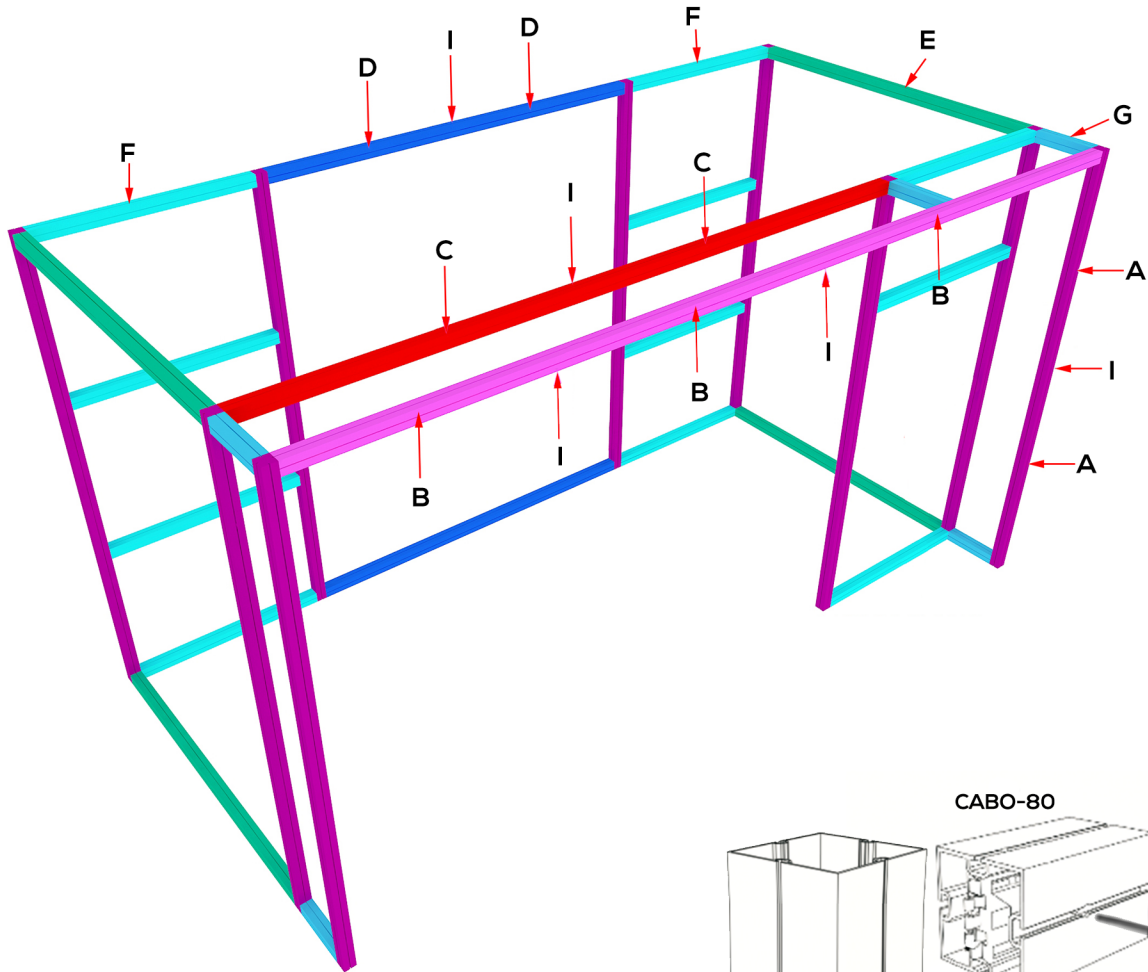

CABO 80 Profile Connection

1. Line up lock with system groove on vertical profile
2. Insert teeth of lock into groove
3. Use torx tool to tighten lock (turn clockwise to tighten)

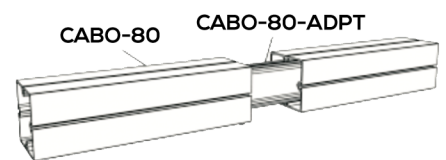

CABO-80-ADPT Connection

1. Insert CABO-80-ADPT into one CABO-80 profile
2. Slide opposing CABO-80 profile onto CABO-80-ADPT
3. Tighten screws on CABO-80-ADPT to secure profiles in place

REF	SKU	QTY	LENGTH
A	CABO-80	18	66.65"
B	CABO-80	3	76.9"
C	CABO-80	2	86.1
D	CABO-80	4	56.9
E	CABO-80	4	94.3"
F	CABO-80	11	55.3"
G	CABO-80	5	16.3"
I	CABO-80-ADPT	14	n/a

SEG Attachments

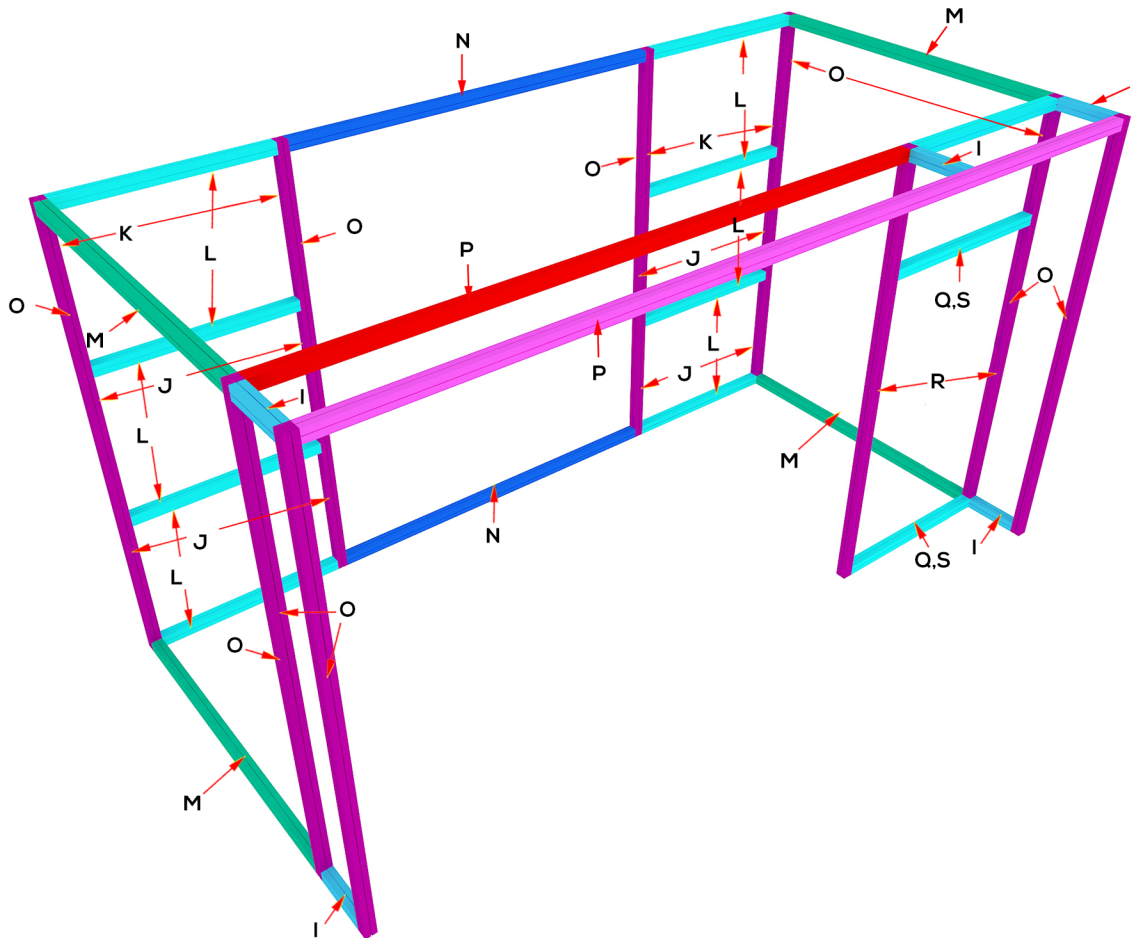

REF	SKU	QTY	LENGTH
I	CABO-SEG-PLASTIC	8	16.3"
J	CABO-SEG-PLASTIC	8	39.3"
K	CABO-SEG-PLASTIC	4	41.9"
L	CABO-SEG-PLASTIC	14	55.2"
M	CABO-SEG-PLASTIC	4	94.2"
N	CABO-SEG-PLASTIC	2	113.7"
O	CABO-SEG-PLASTIC	10	126.9"
P	CABO-SEG-PLASTIC	2	172.2"
Q	CABO-80-SEG	2	55.2"
R	CABO-80-SEG	2	94.4"
S	CABO-HHS	25	n/a

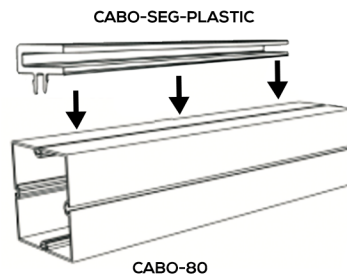

- CABO-SEG-PLASTIC Installation**
1. Line up clip of CABO-SEG-PLASTIC with system groove of profile
 2. Press CABO-SEG-PLASTIC down to lock into place.

Template Guide

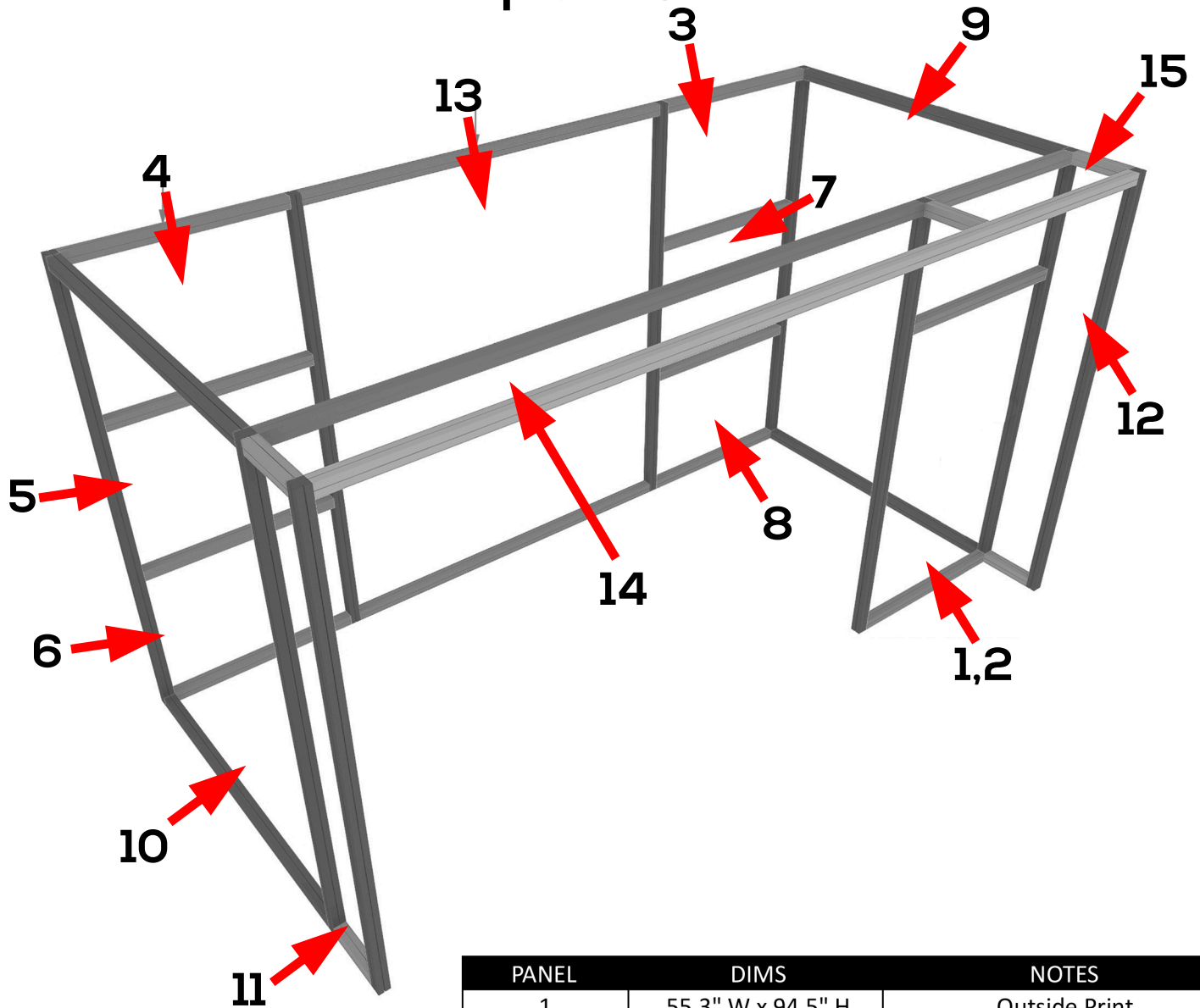

PANEL	DIMS	NOTES
1	55.3" W x 94.5" H	Outside Print
2	55.3" W x 94.5" H	Inside Print
3	55.3" W x 39.4" H	Inside Print Top
4	55.3" W x 39.4" H	Inside Print Top
5	55.3" W x 42" H	Inside Print Middle
6	55.3" H x 39.4" H	Inside Print Bottom
7	55.3" H x 42" H	Inside Print Middle
8	55.3" H x 39.4" H	Inside Print Bottom
9	94.3" H x 127" H	Inside Print
10	94.3" H x 127" H	Inside Print
11	16.3" W x 127" H	Inside Print
12	16.3" W x 127" H	Inside Print
13	113.8" W x 127" H	Inside Print
14	172.2" W x 16.3" H	Blank Archway Bottom
15	55.3" W x 16.3" H	Blank Archway Bottom